



88246 EC #87120 CHROME  **1.75 GPM**  
88546 EC #87120-BN BRUSHED NICKEL





# POWERMASSAGE FIXED



-  Chrome
-  Brushed Nickel

## SETTINGS:



-  Multi Oxygenics
-  WideStream
-  FocusStream
-  Massage
-  Flood

## GENERAL DESCRIPTION:

The PowerMassage is a versatile, high-performance shower head that **COMBINES FLEXIBILITY WITH INCREASED POWER AND LARGE-SCALE SAVINGS**. Quality construction means it won't clog and the powerful spray drastically reduces tampering, resulting in a quality shower head that won't under perform and saves you money and time.

## PRODUCT FEATURES:

- + Multi Oxygenics setting with dual Oxygenics engines **increases water pressure**.
- + **Efficient design** reduces water usage without limiting power.
- + **Reduces water and energy** costs by up to **\$130+ per year**.
- + **5 spray settings** adjust coverage from wide to focused.
- + Intuitive spray selector makes **changing settings easy**, even with wet hands.
- + Internal parts made from acetal resin **prevent hard mineral buildup and clogging**.

**EQUIPARTS**  
Repair Parts Specialists®  
TOLL FREE: 800-442-6622  
PITTSBURGH: 412-781-9100  
[www.equiparts.com](http://www.equiparts.com)  
**That Hard to Find Part is Right Here!**

## PRODUCT SPECIFICATIONS:

- DIMENSIONS:** 3.35" x 3.75" x 3.35"
- WEIGHT:** 1 lb.
- MAX FLOW RATE:** 1.75 GPM
- AVAILABLE FINISHES:** Chrome, Brushed Nickel

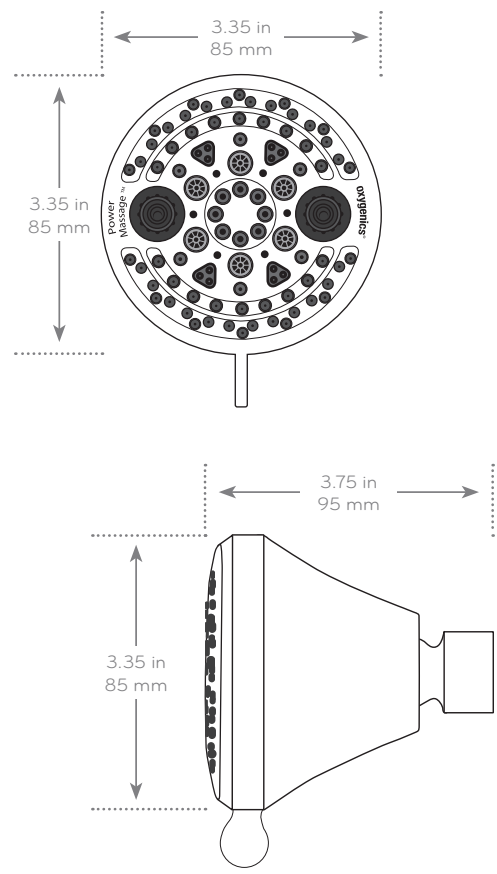

## SUGGESTED SPECIFICATION:

The multifunction shower head features 5 spray modes: Multi Oxygenics, WideStream, FocusStream, Massage and Flood. Shower head features non-stick internal parts coated in acetal resin to eliminate clogging and mineral build-up. Shower head has a 3.35" (85 mm) diameter spray face. Shower head available in chrome and brushed nickel finishes and 1.75 gal/min (6.6 l/min).

## CODES AND STANDARDS:

1.75 GPM products meet or exceed the following flow rate standards:



## WHAT'S INCLUDED:

- + Fixed Shower
- + Plumber's Tape

## FLOW RATE:

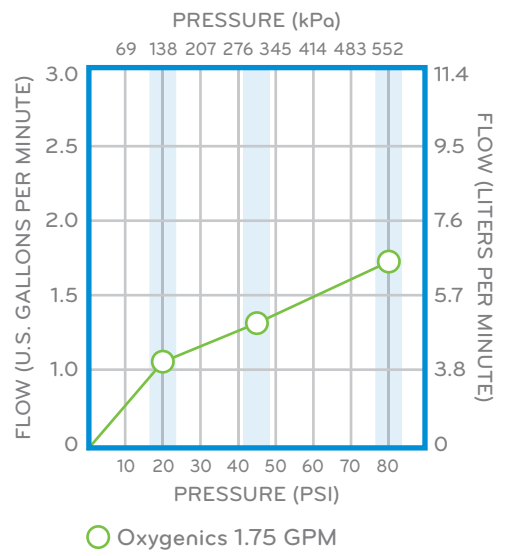

## APPLICATIONS:



**"NEVER CLOG!" Warranty**

Limited lifetime performance warranty against failure or clogging.