

PRODUCT SPECIFICATIONS

Elkay Soft Sides® Single ADA Fountain Non-Filtered Non-Refrigerated Stainless. Furnished with Flexi-Guard® Safety Bubbler. Mechanical Front Bubbler Button activation. Product shall be Wall Mount (On Wall), for Indoor + Outdoor applications, serving 1 station(s). Unit shall be lead-free design which is certified to NSF/ANSI 61 & 372 (lead free) and meets Federal and State low-lead requirements.

Finish:	Stainless Steel
Power:	No Electrical Required
Bubbler Style:	Flexi-Guard® Safety Bubbler
Activation by:	Mechanical Front Bubbler Button
Mounting Type:	Wall Mount (On Wall)
Chilling Capacity:	Non-refrigerated
Dimensions (L x W x H):	12-1/8" x 18-3/4" x 6-1/2"
Approx. Shipping Weight:	16 lbs.
Installation Location:	Indoor + Outdoor
No. of Stations Served:	1

**When used in non-temperature controlled environments, unit(s) must be adequately winterized and/or protected from extreme heat to prevent damage where climates dictate.

- Mechanically-Activated bubbler continues to supply water in event of service disruptions.



Included with Product: Fountain
Ships in one box.

A Century of Tradition and Quality. For more than 100 years, Elkay has been making innovative products and providing exceptional customer care. We take pride in offering plumbing products that make life easier, inspire change and leave the world a better place.



PRODUCT COMPLIANCE

- ADA & ICC A117.1
- ASME A112.19.3/CSA B45.4
- Buy American Act
- NSF/ANSI 61 & 372 (lead free)



Complies with ADA & ICC A117.1 accessibility requirements when installed according to the requirements outlined in these standards. Installation may require additional components and/or construction features to be fully compliant. Consult the local Authority Having Jurisdiction if necessary.

[Installation Instructions \(PDF\) - 97156C](#)

Water Systems are warranted for 12 months from date of installation.

Warranty pertains to drinking water applications only. Non-drinking water applications are not covered under warranty.

[Warranty \(PDF\)](#)

PART: _____ QTY: _____

PROJECT: _____

CONTACT: _____

DATE: _____

NOTES: _____

APPROVAL: _____





TMS EQUIPARTS
NORTHEAST

TOLL FREE: 800-442-6622
PITTSBURGH: 412-781-9100
www.equiparts.net

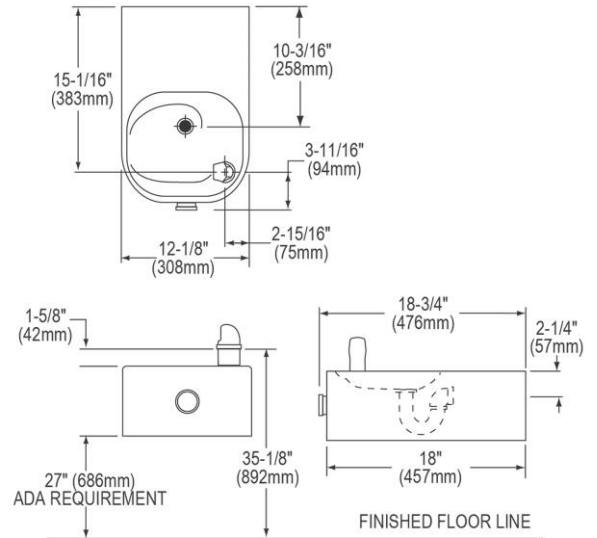
That Hard to Find Part is Right Here!

In keeping with our policy of continuing product improvement, Elkay reserves the right to change product specifications without notice. Please visit elkay.com for the most current version of Elkay product specification sheets. This specification describes an Elkay product with design, quality, and functional benefits to the user. When making a comparison of other producers' offerings, be certain these features are not overlooked.



Optional Accessories		
EWF172	Elkay WaterSentry VII Filter Kit (Coolers + Fountains) Spec Sheet (PDF)	
MPW101	In-wall Mounting Plate for Single-station Non-refrigerated Fountains Spec Sheet (PDF)	
WP2	Wall Plate for EDFP210C and EDFP214C fountains Spec Sheet (PDF)	
AP99	Elkay Access Panel 9" x 9" x 6" Spec Sheet (PDF)	



In keeping with our policy of continuing product improvement, Elkay reserves the right to change product specifications without notice. Please visit elkay.com for the most current version of Elkay product specification sheets. This specification describes an Elkay product with design, quality, and functional benefits to the user. When making a comparison of other producers' offerings, be certain these features are not overlooked.

INSTALLER NOTE

This drinking fountain is furnished with a bubbler and valve including all connecting fittings which are manufactured of completely lead free material. Shut off valve (not furnished) to accept 3/8" O.D. unplated copper tube.

OPERATION OF QUICK CONNECT FITTINGS

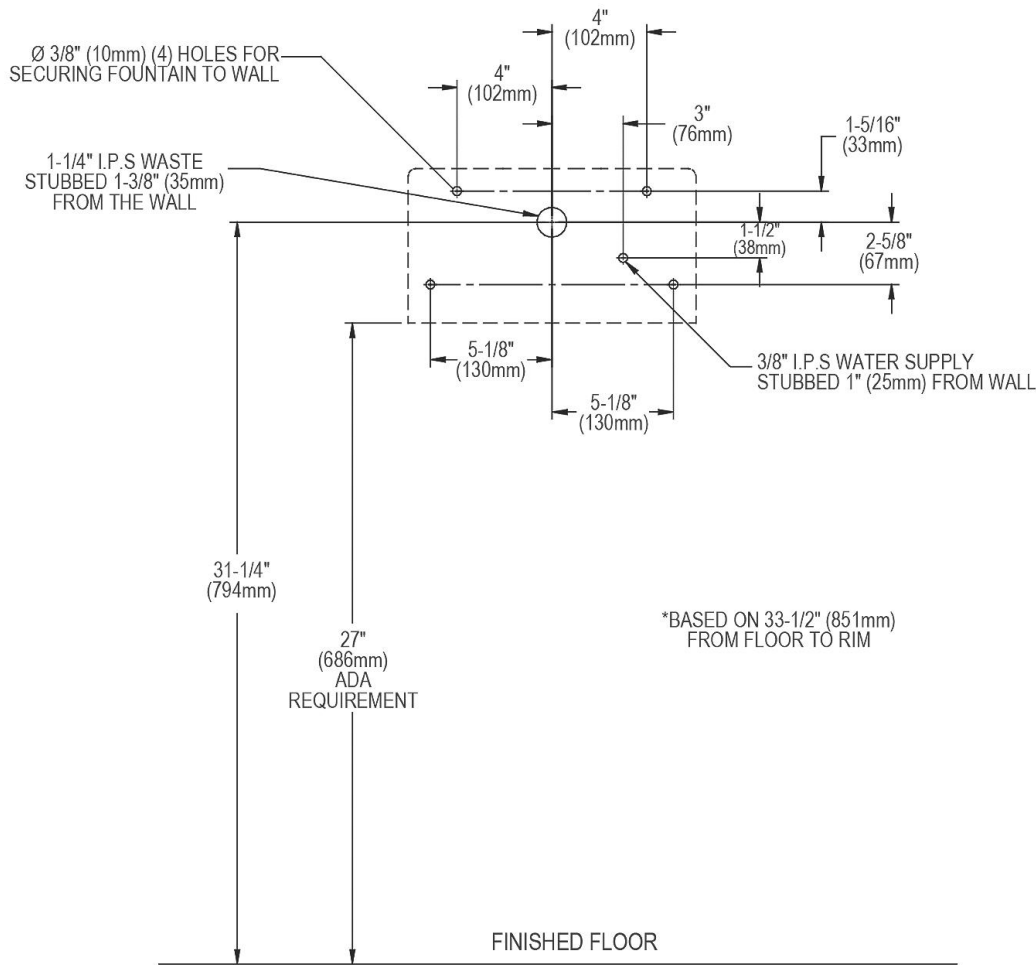
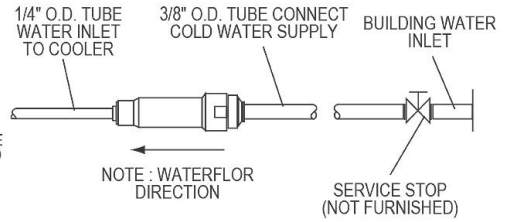
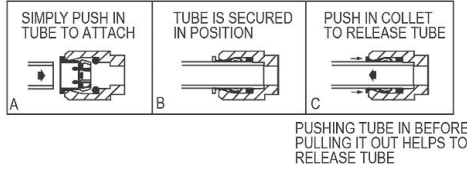

TMS **EQUIPARTS**
NORTHEAST

TOLL FREE: 800-442-6622
PITTSBURGH: 412-781-9100
www.equiparts.net
That Hard to Find Part is Right Here!

In keeping with our policy of continuing product improvement, Elkay reserves the right to change product specifications without notice. Please visit elkay.com for the most current version of Elkay product specification sheets. This specification describes an Elkay product with design, quality, and functional benefits to the user. When making a comparison of other producers' offerings, be certain these features are not overlooked.