

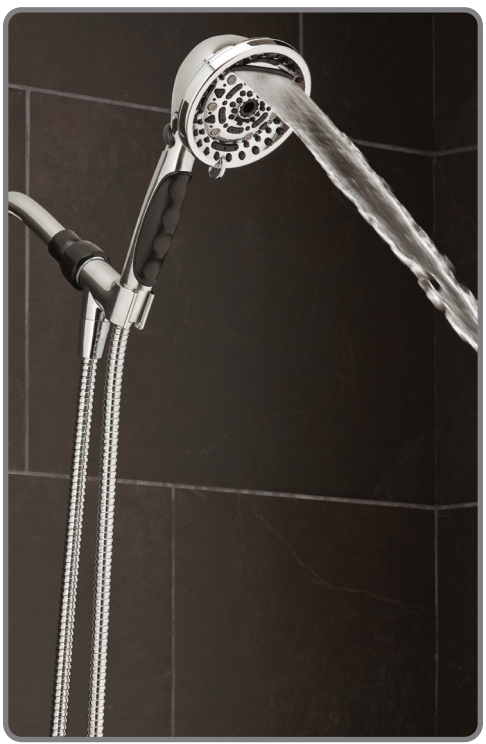

52188 EC #22592 CHROME  **1.8 GPM**
52488 EC #22592-BN BRUSHED NICKEL

POWERMAX HANDHELD



-  Chrome
-  Brushed Nickel

SETTINGS:





Oxygenics



Waterfall



WideStream

FocusStream

WideStream
+FocusStream

Massage

WideStream
+Massage

Flood

SmartPause®

EQUIPARTS
Repair Parts Specialists®

TOLL FREE: 800-442-6622
PITTSBURGH: 412-781-9100

www.equiparts.com

That Hard to Find Part is Right Here!

GENERAL DESCRIPTION:

The PowerMax handheld takes the same combination of strength and comfort as the PowerMax fixed and adds the flexibility of a handheld unit. **CUTTING-EDGE TECHNOLOGY FOCUSES POWER THROUGH NINE DIFFERENT SPRAY SETTINGS**, while superior quality and construction ensure that this handheld will continue to perform for a lifetime.

PRODUCT FEATURES:

- + **9 pressure boosting settings** including a unique Waterfall spray setting.
- + **4.5" spray face** adds coverage for better rinsing.
- + Non-slip rubber grip means **no more fumbling with a slippery, soapy handheld**.
- + **Includes a 72" stainless steel hose** for expanded reach and ease of rinsing.
- + **Saves up to \$125+ per year** without sacrificing shower strength.
- + **Non-stick internal parts** prevent clogging or corrosion for consistent performance.

PRODUCT SPECIFICATIONS:

DIMENSIONS: 4.5" x 3.125" x 9.75"
WEIGHT: 2 lbs.
MAX FLOW RATE: 1.8 GPM
AVAILABLE FINISHES: Chrome, Brushed Nickel

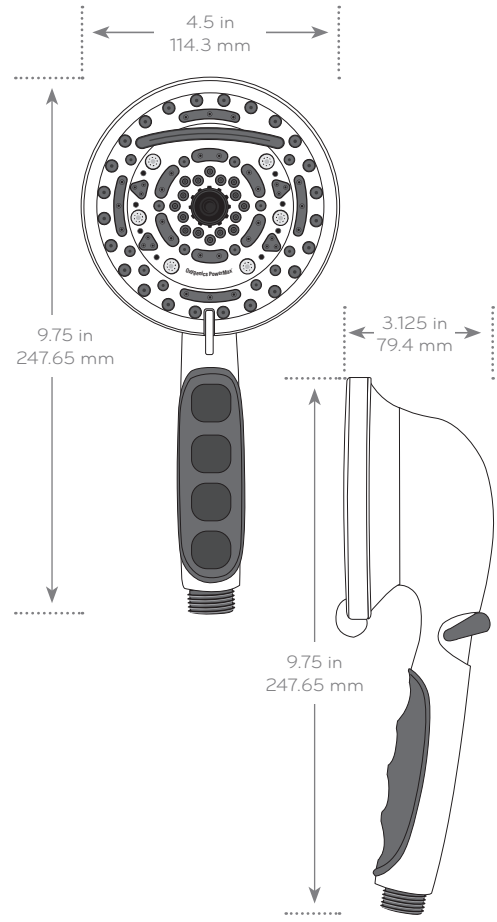

SUGGESTED SPECIFICATION:

Multifunction shower head features 9 spray modes: Oxygenics, Waterfall, WideStream, FocusStream, WideStream+FocusStream, Massage, WideStream+Massage, Flood and SmartPause. Shower head features non-stick internal parts coated in acetal resin to eliminate clogging and mineral build-up. Shower hose made of metal and is 72" (182.8 cm) in length. Includes arm mount. Shower head has a 4.5" (114.3 mm) diameter spray face. Shower head available in chrome and brushed nickel finishes and 1.8 GPM (6.8 L/min)

CODES AND STANDARDS:

1.8 GPM products meet or exceed the following flow rate standards:



WHAT'S INCLUDED:

- + Handheld Shower
- + Holder
- + 72" Stainless Steel Hose
- + Plumber's Tape

FLOW RATE:

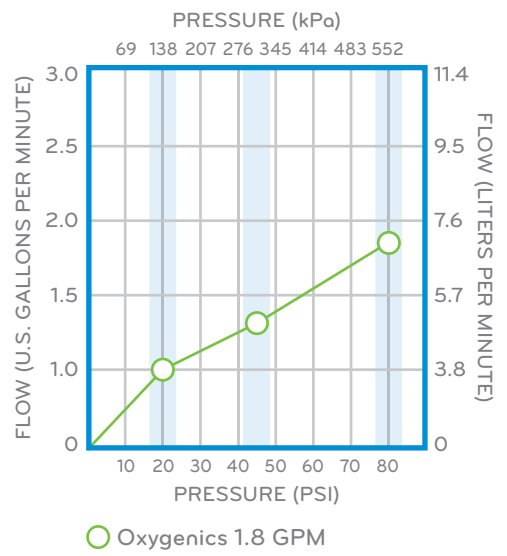

APPLICATIONS:



"NEVER CLOG!" Warranty

Limited lifetime performance warranty against failure or clogging.